

Kaldera 2

KAL2-N-SW-IO

KAL2-N-LH-SW-IO

KAL2-N-RH-SW-IO



Built-in tub suitable for drop-in or undermount

- Made from ENGLISHCAST™
 - One piece casting of Volcanic Limestone™ and resin
 - Harder & more durable than acrylic
- Easy clean high gloss finish
- Maximum design flexibility choose drop-in or undermount installation
- Accurate diamond cut edge
- Easy step in height of 19" – ADA compliant
- Internal Overflow
- 4 adjustable feet for levelling
- Choice of a 1/16" Stainless Steel tile flange on three sides of the tub for a water-tight seal
- 25 year warranty



Baignoire adaptée à une pose sur podium ou encastrée

- Fabriquée en ENGLISHCAST™
 - Ensemble d'une pièce en pierre volcanique rare et résine
 - Matériau plus dur et plus résistant que l'acrylique
- Fini ultra brillant, facile à nettoyer
- Flexibilité maximale en matière de design, offrant au choix une installation podium ou encastrée
- Bords découpés avec précision
- Facilité d'insertion avec une hauteur de 48,26 cm – conforme aux normes ADA
- Trop-plein intégré
- 4 pieds de nivellement réglables
- Possibilité d'une bride de carrelage en acier inoxydable de 1/16" sur trois côtés de la baignoire pour une parfaite étanchéité
- Garantie de 25 ans



Bañera encastrada, ideal para montaje encastrado o bajo encimera

- Hecho de ENGLISHCAST™
 - Hecho en una pieza de piedra volcánica y resina
 - Más resistente y duradero que acrílico
- Fácil de limpiar y acabado brillante
- Máxima flexibilidad en el diseño para instalarla encastrada
- Sobre encimera
- Bordes con corte de diamante
- Acceso sencillo gracias a su altura de 19" (conformidad con la ADA)
- Sistema de rebosadero integrado
- 4 pies ajustables para un perfecto nivelado
- Un reborde tipo baldosa de 1/16" en acero inoxidable en tres bordes de la bañera para un sellado que impide la filtración de agua
- 25 años de garantía

25
years

Warranty for residential use for 25 years
25 ans de garantie pour un usage domestique
Garantía de 25 años para uso domestico

8
years

Warranty for commercial use for 8 years
8 ans de garantie pour un usage commercial
Garantía de 8 años para uso comercial

Kaldera 2

KAL2-N-SW-IO / KAL2-N-LH-SW-IO / KAL2-N-RH-SW-IO

victoria ⊕ albert®

volcanic limestone baths

Recommended: K13

Conseillé / Recomendado



K13

Related collections

Collections connexes / Colecciones relacionadas



Kaldera 56 - UB-KAL-56-IO



Drop-in

Kaldera 2

KAL2-N-SW-IO / KAL2-N-LH-SW-IO / KAL2-N-RH-SW-IO

Top view

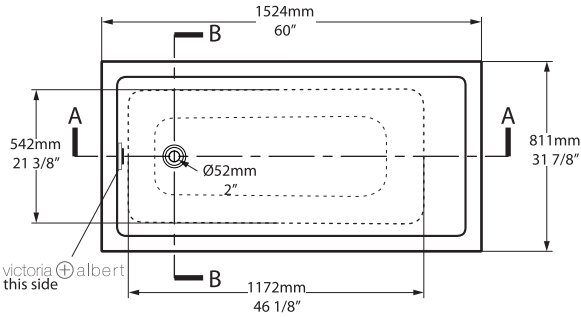

Front view

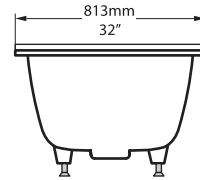

Side view

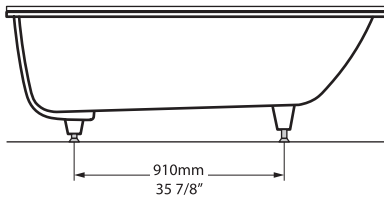

Section BB

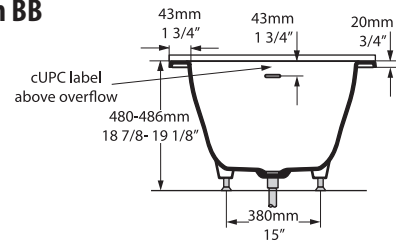

Flange detail

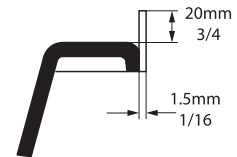



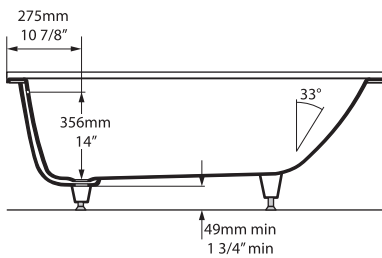



Section AA

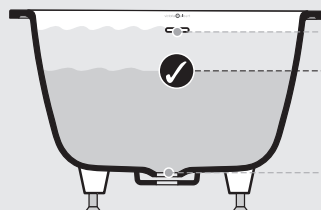
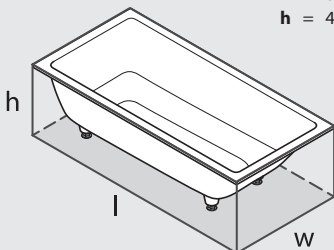

*All measurements subject to +/-5% tolerance

l = 1524mm / 60"
w = 813mm / 32"
h = 480-486mm / 18⁷/₈-19¹/₈"



 646	 64 US gal
 443	 39 ³ / ₄ US gal
 112	 0 US gal



.dwg | .dxf | .skp www.vandabaths.com



Massachusetts Code: Approved
 cUPC listing by IAPMO: File No. pending



VA/1181/03/June20